

# SUNSHOWER DELUXE HEALTH

## PART I: BUILDING THE FALSE WALL

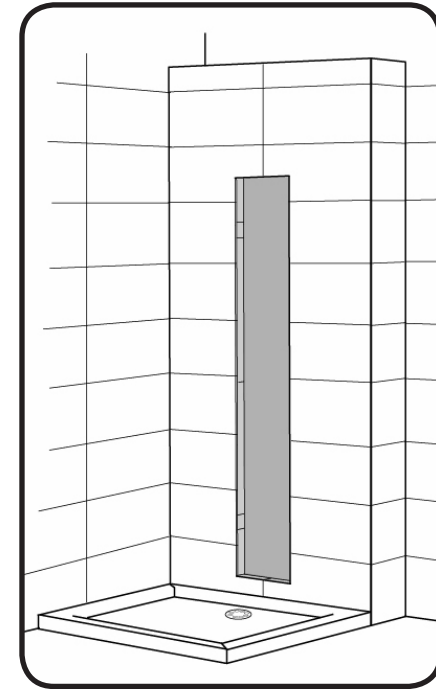

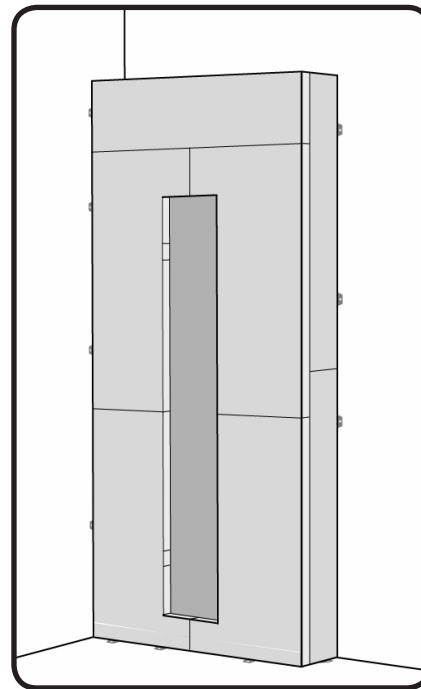
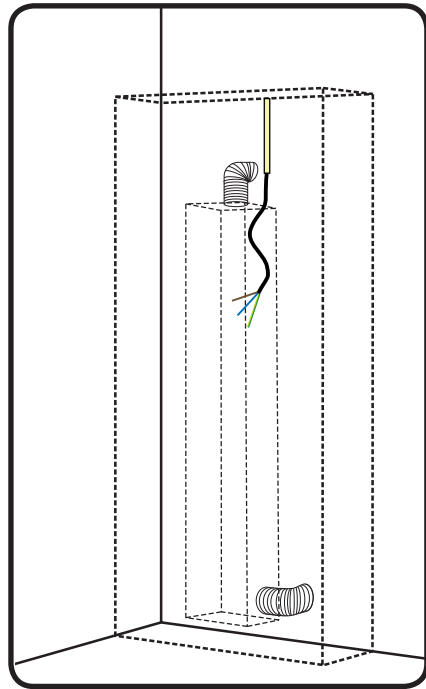

## In box: / In doos: / In Box:

Decorative frame

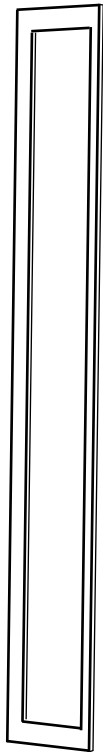

Large glass frame

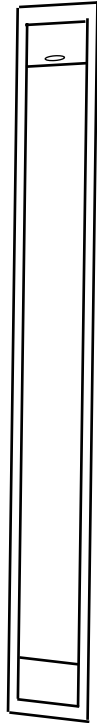

Small glass frame



Housing

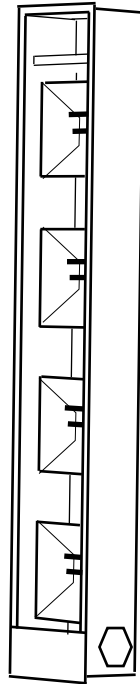

Wallframe

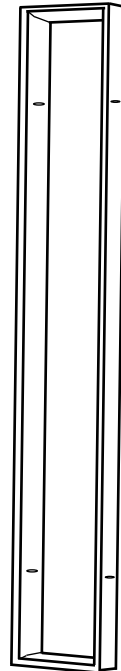

## Supplied / Meegeleverd / Mitgeliefert

10x



6x



2x

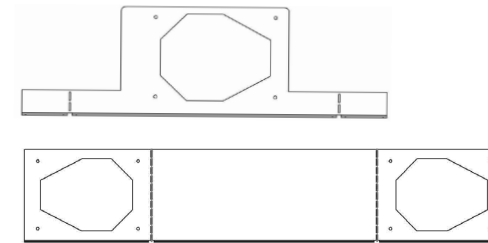

## NOT Supplied / NIET Meegeleverd / NICHT Mitgeliefert

2x

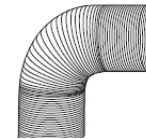

2x

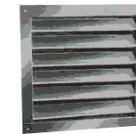

4x

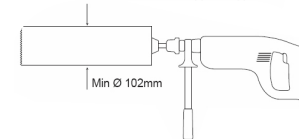
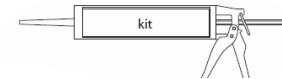
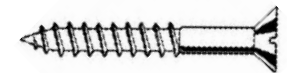

Min Ø 102mm



4m

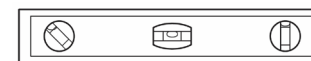

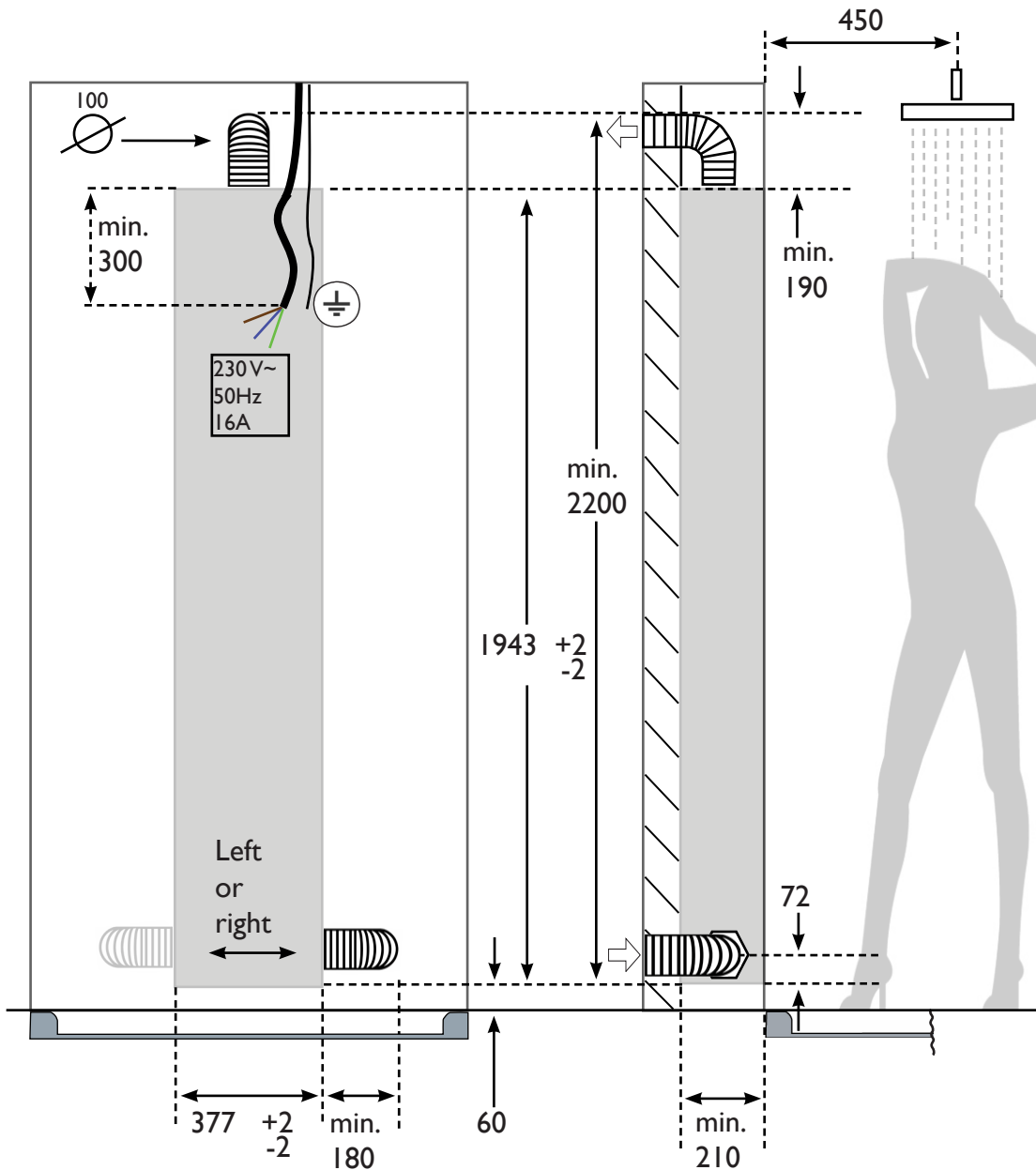

Requirements/Benodigdheden/Bedarfsartikel

4m

3D example/ 3D voorbeeld/ 3D Beispiel

Instructions/Instructies/Anleitung

EN: All dimensions in mm

NL: Alle bematingen in mm

DE: Alle Maßzahlen in mm

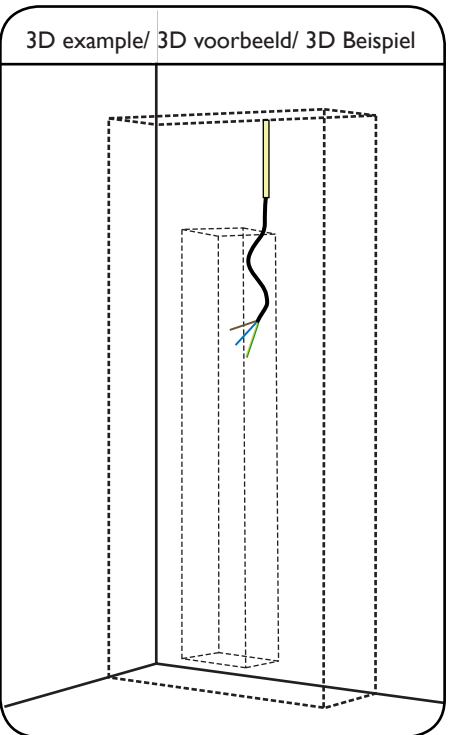
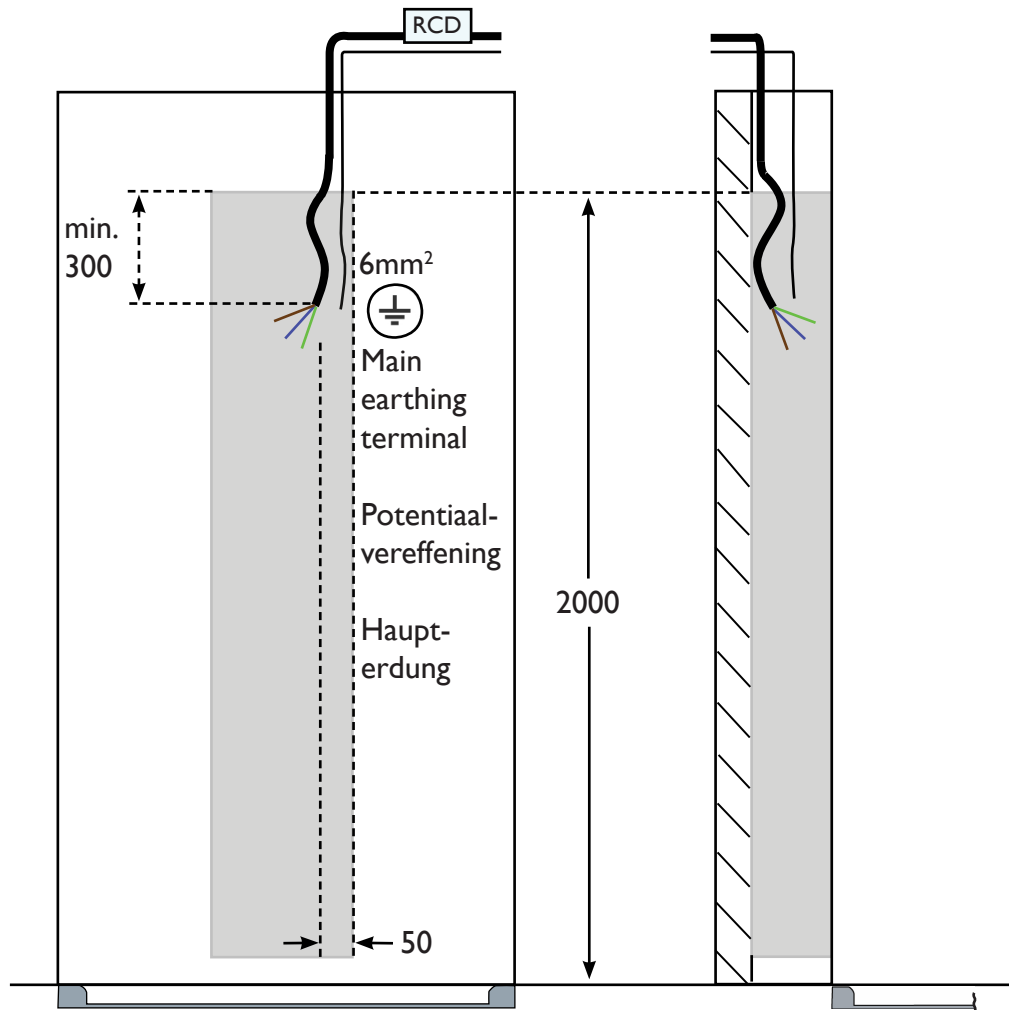

## Instructions/Instructies/Anleitung

**YmVk min. 2.5mm<sup>2</sup> 230V~ 50Hz I 6A**

EN: Residual current device 30mA (RCD)

NL: Aparte eindgroep voorzien van een aardlekschakelaar 30mA

DE: Separater FI LS, Type Möller, PKNM16/IN 16B-0,03-G oder gleichwertig

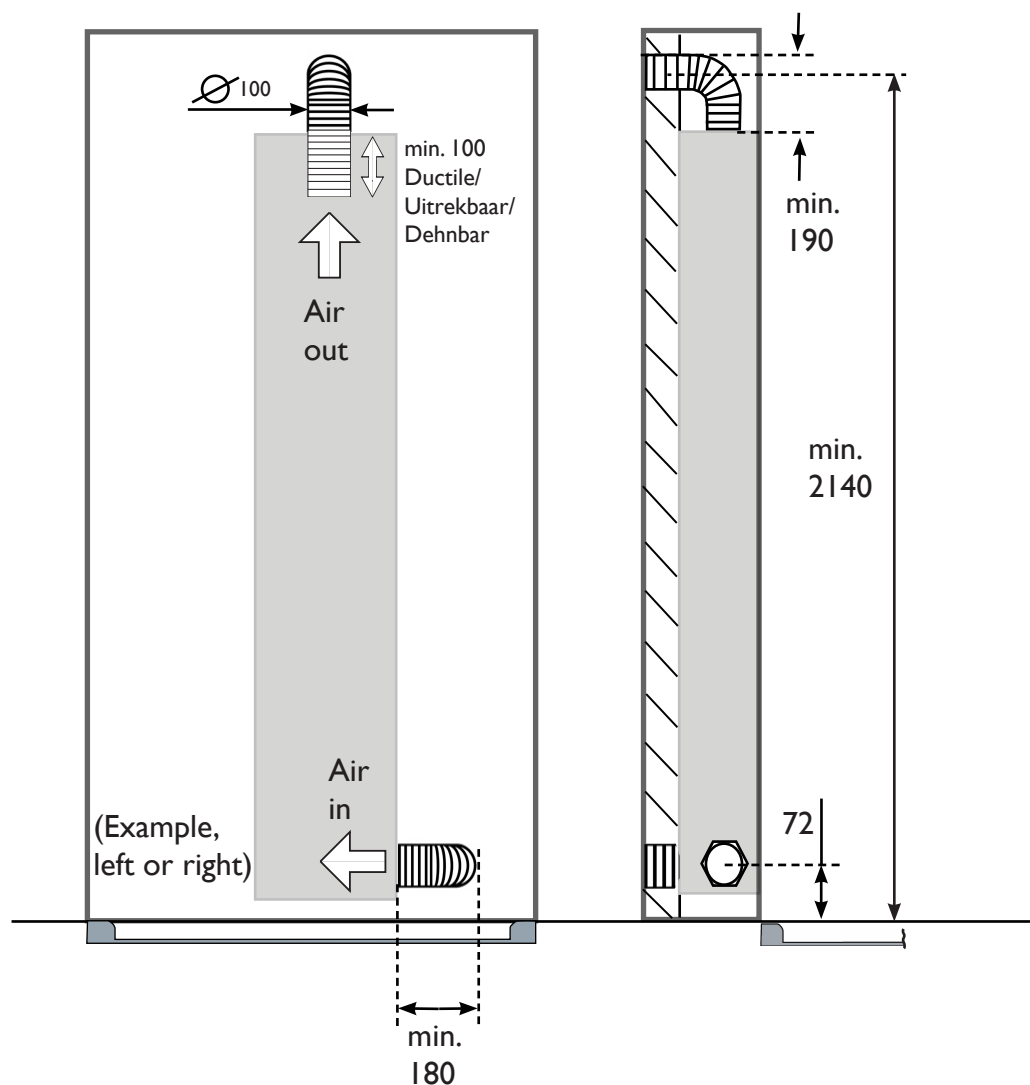

## Requirements/Benodigdheden/Bedarfsartikel

Flexible Ducting/  
Flexibele afvoer/  
Absugsrohr

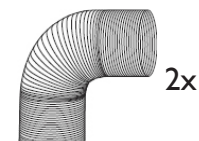

Louver/  
Ventilatioerooster/  
Lüftschlitz

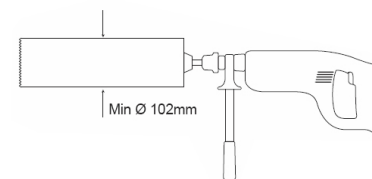
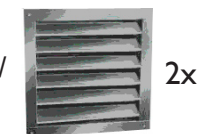

## 3D example/ 3D voorbeeld/ 3D Beispiel

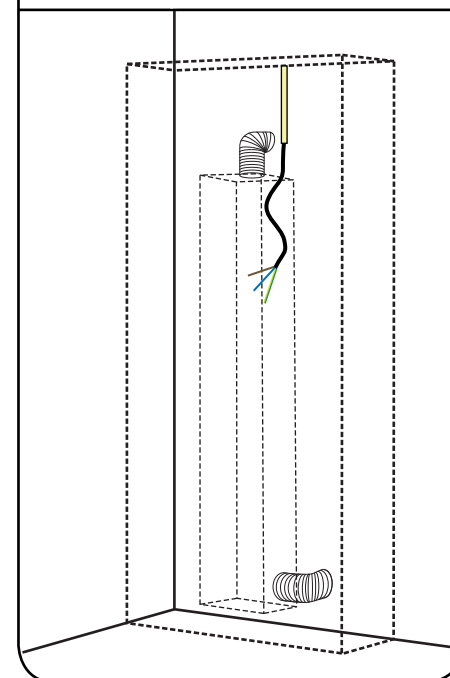

## Instructions/Instructies/Anleitung

- EN: Ventilation to other dry area of 12M<sup>3</sup> or bigger / Outside
- NL: Ventilatie naar andere ruimte van minimaal 12M<sup>3</sup> / Buiten
- DE: Lüftung nach anderes Raum von mindestes 12M<sup>3</sup> / ins Freie entlüften

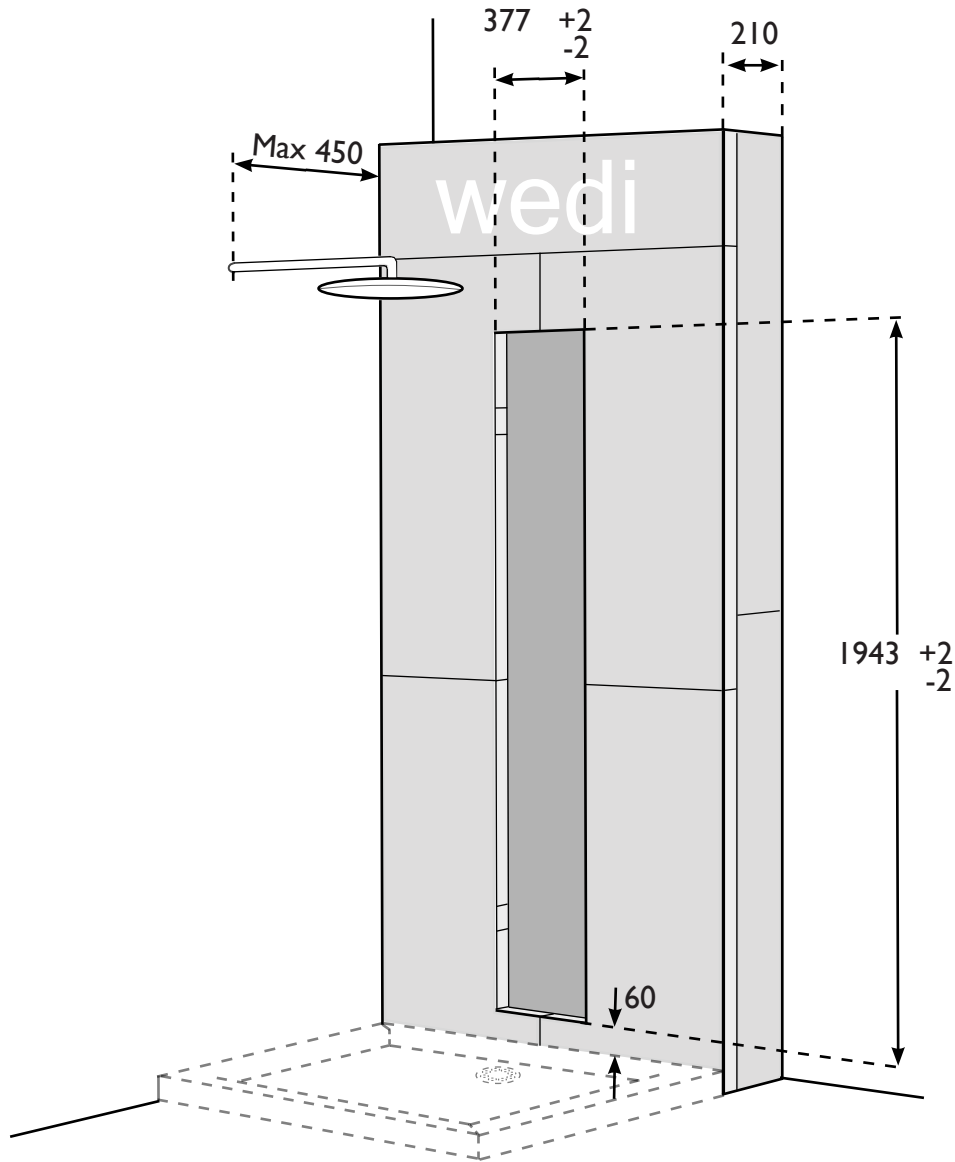

Requirements/Benodigdheden/Bedarfsartikel

Wedi-wall

kit

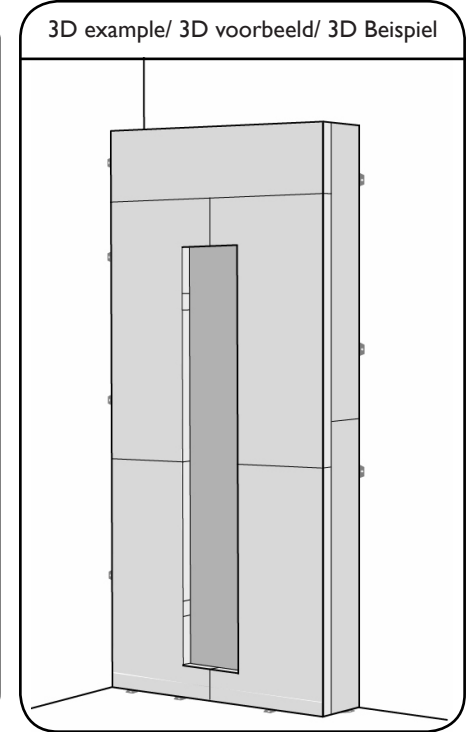

Instructions/Instructies/Anleitung

EN: For full manual, check the Wedi instructions. For other wall see section 4B

NL: Voor volledige instructies, zie wedi wand handleiding. Voor ander type muur zie hoofdstuk 4B

DE: Für das komplette Handbuch, guck am Wedi Anleitung. Für andere wand siehe Abschnitt 4B

Wedi wall instructions

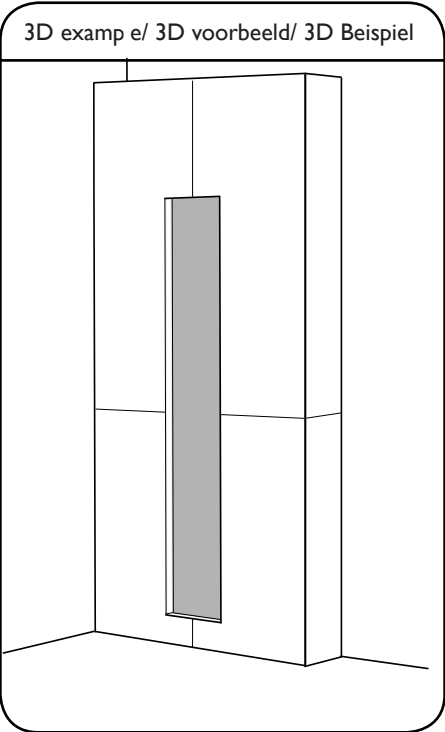
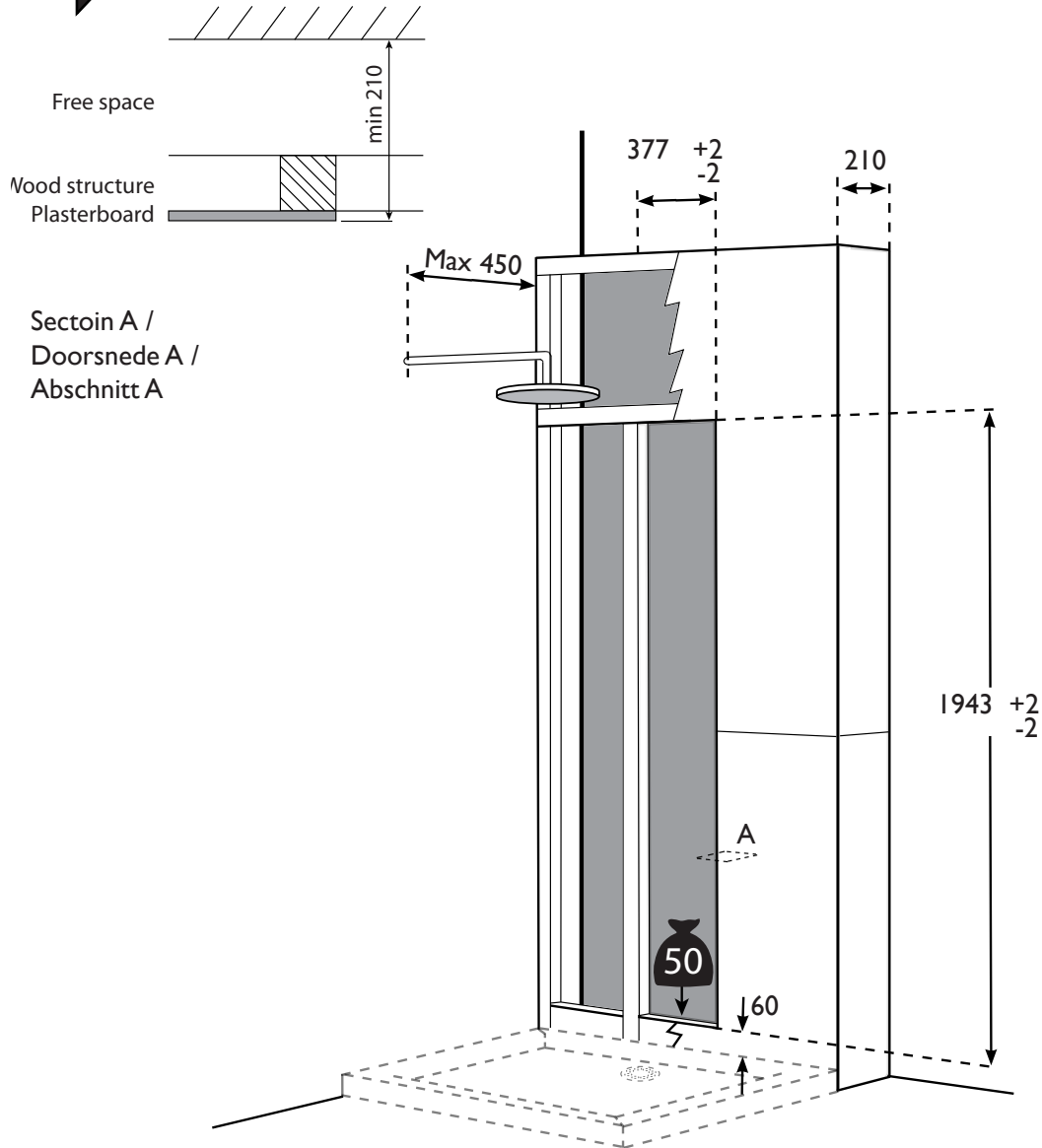

Instructions/Instructies/Anleitung

- EN: The construction should be able to hold 50 kg.
- NL: De constructie dient minimaal 50kg te kunnen dragen.
- DE: Der Bau sollte in der Lage zu 50 kg zu halten.

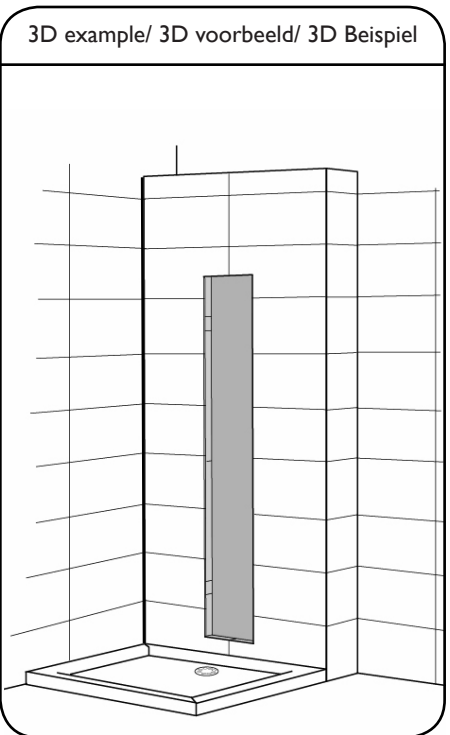
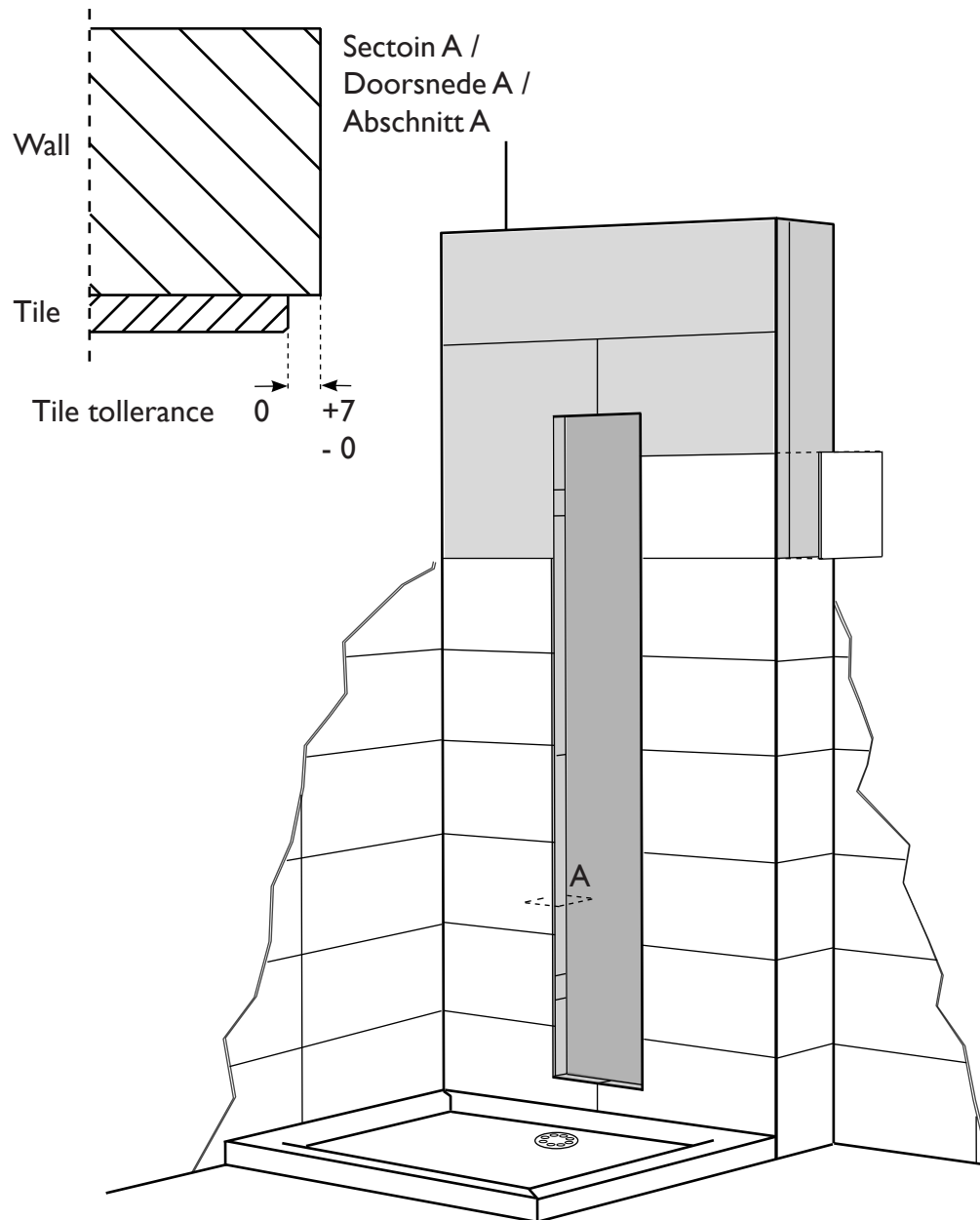

6

# Wall frame / Wandframe / Wall Frame



SUNSHOWER

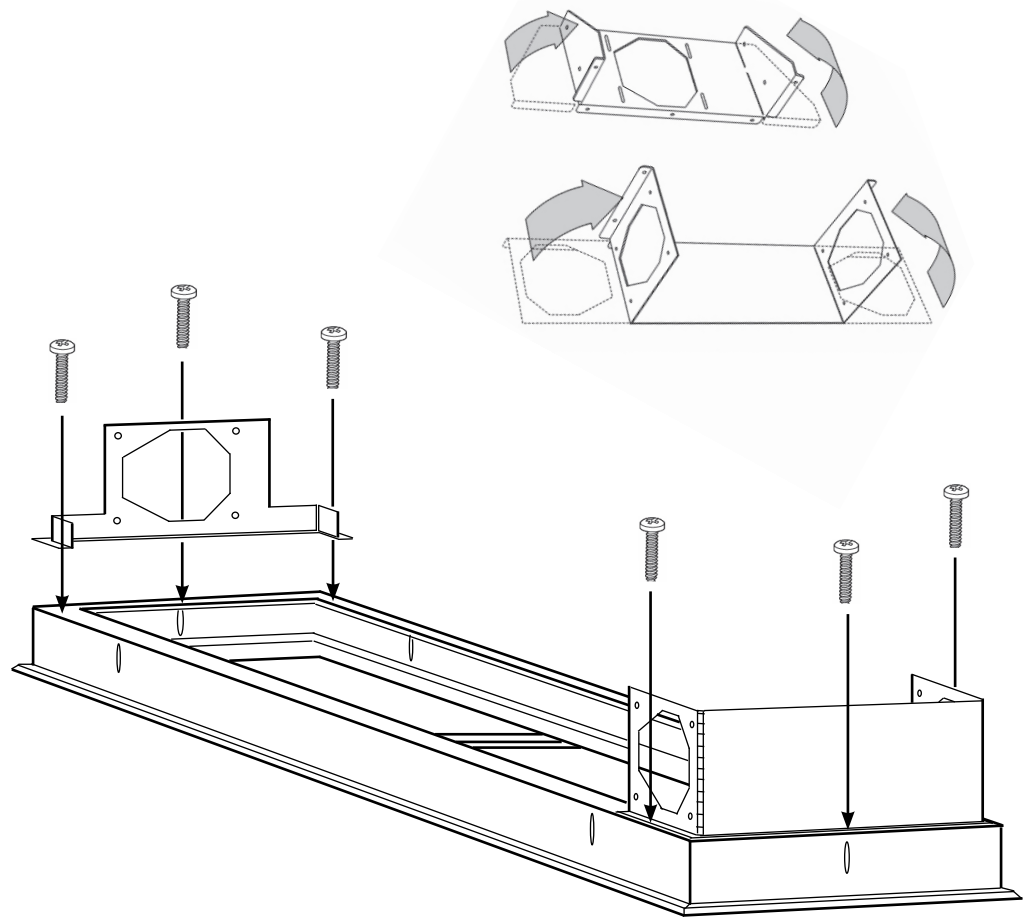

Requirements/Benodigdheden/Bedarfsartikel

6 x

3D example/ 3D voorbeeld/ 3D Beispiel

# 7 Wall frame / Wandframe / Wall Frame



SUNSHOWER

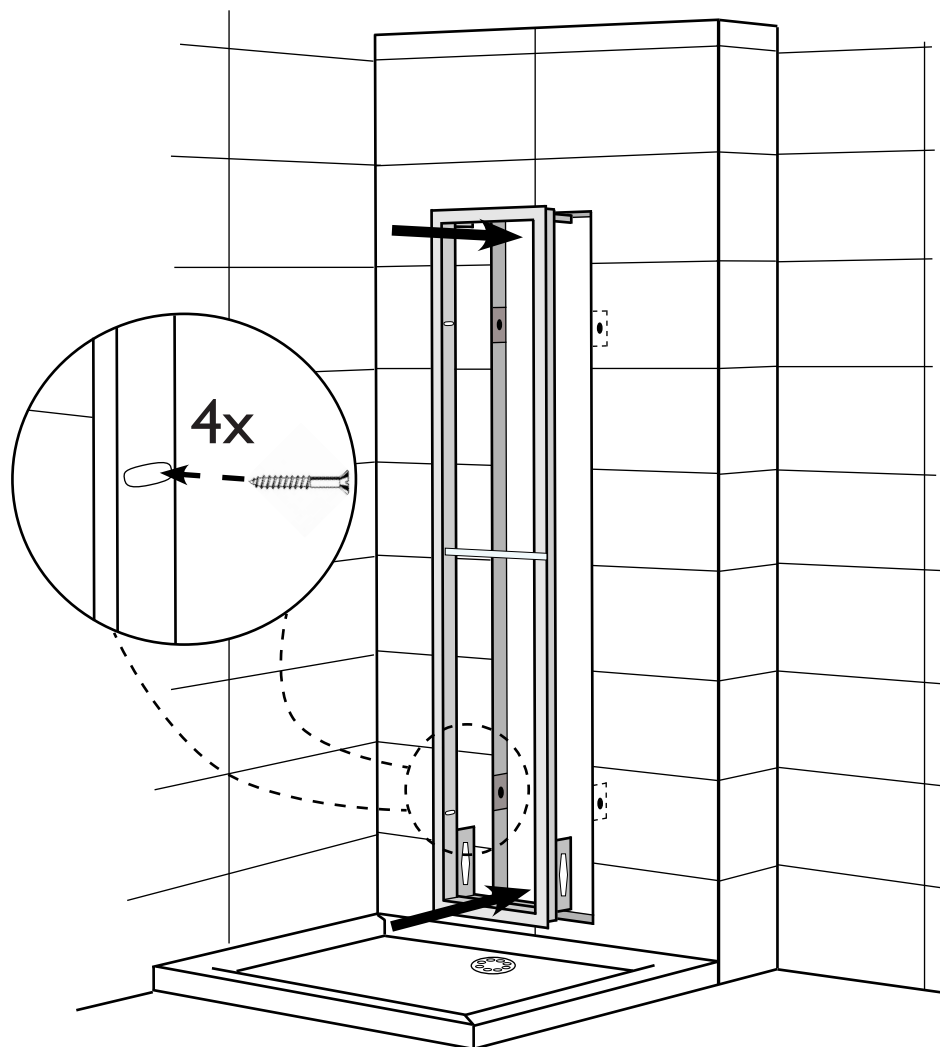

Requirements/Benodigdheden/Bedarfsartikel

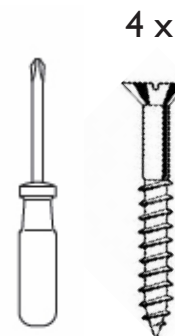

3D example/ 3D voorbeeld/ 3D Beispiel

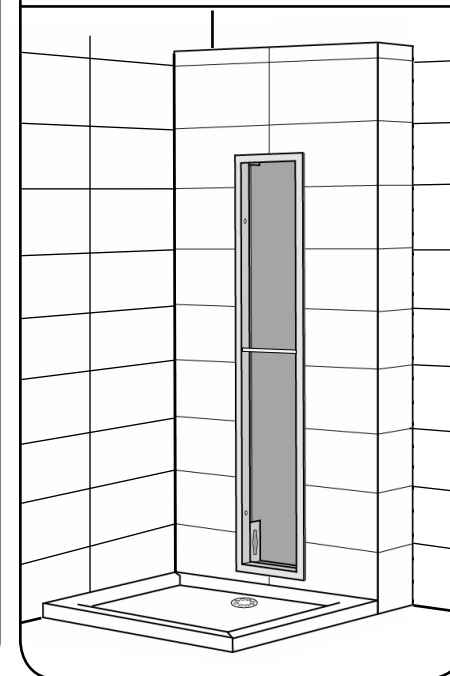

Instructions/Instructies/Anleitung

EN: Screw together at the four black dots

NL: Schroef vast op de vier zwarte punten

DE: Anschrauben an die vier schwarze Punkten

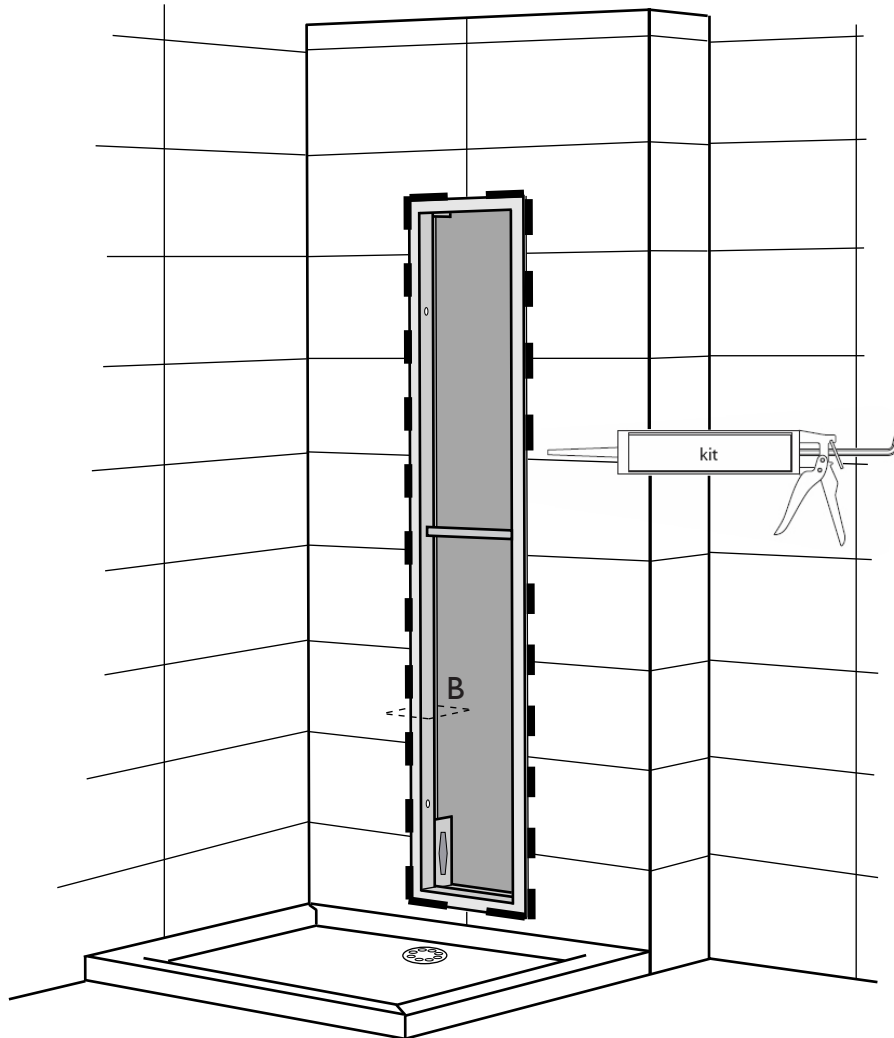

2D example/ 2D voorbeeld/ 2D Beispiel

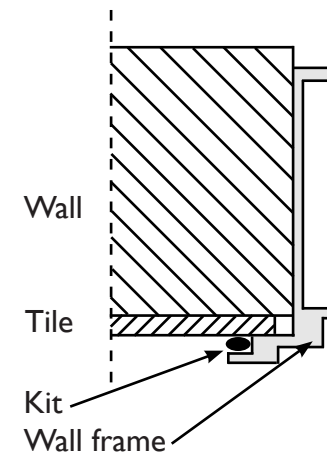
Sectoin B /  
Doorsnede B /  
Abschnitt B

Requirements/Benodigdheden/Bedarfsartikel

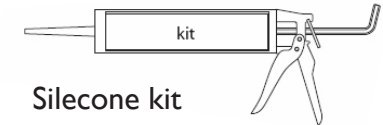
Silecone kit  
Siliconenkit  
Silikonkit

Instructions/Instructies/Anleitung

- EN: Kit the ridge with silecone kit
- NL: Buitenrand afkitten met siliconenkit
- DE: der Rand kitten mit Silikonkit

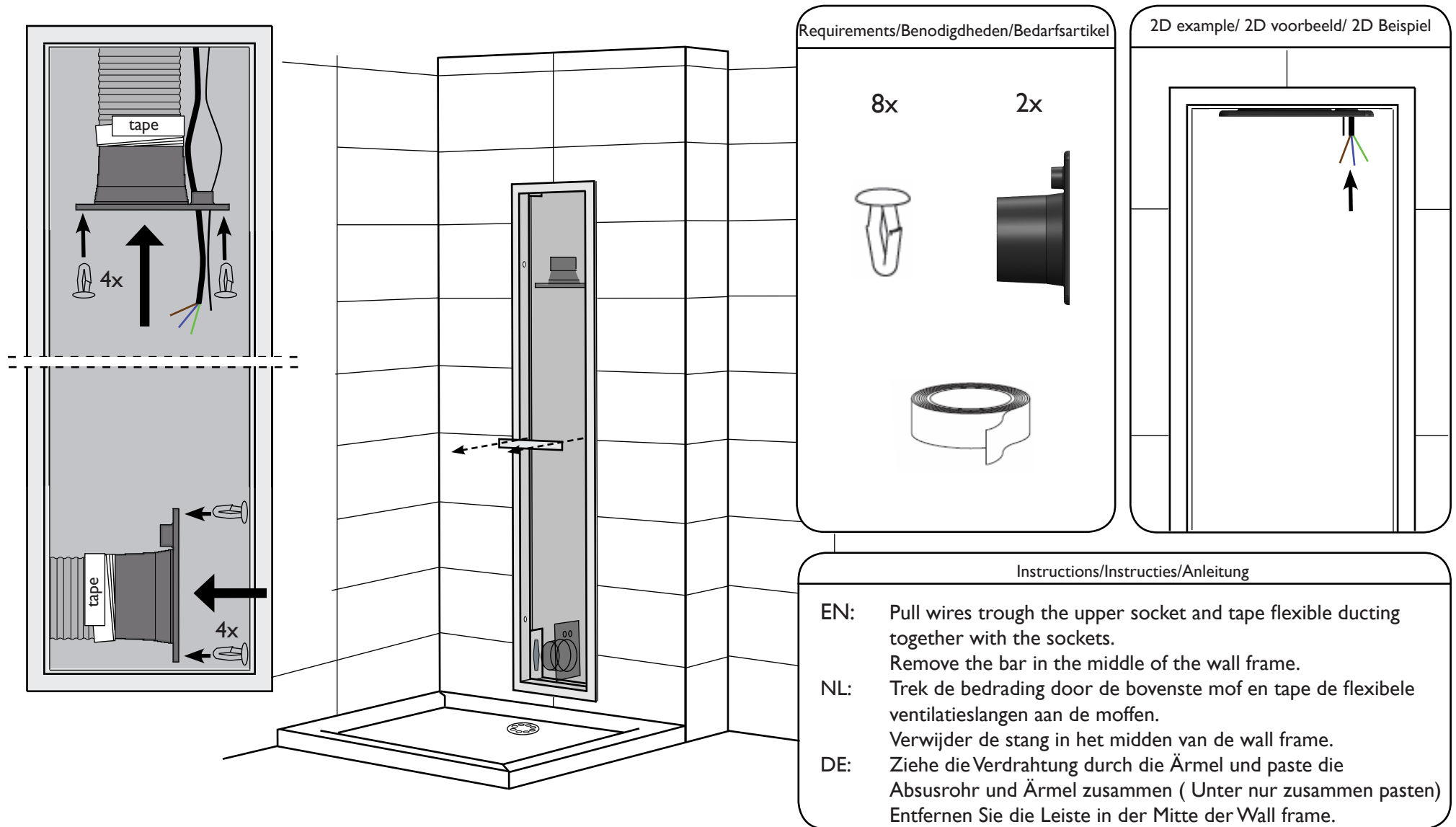

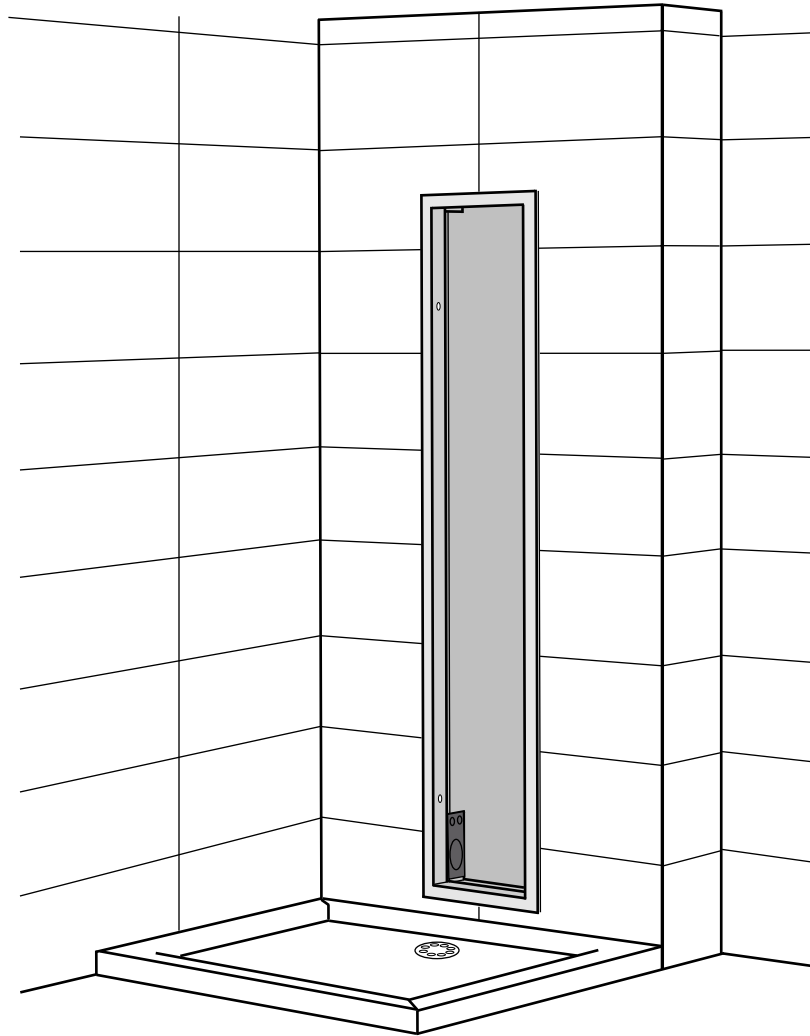

Part 2 / Deel 2 / Teil 2



User manual



Instructions/Instructies/Anleitung

- EN: Part I is finished, continue with part 2; installing the Sunshower Deluxe Health.
- NL: Deel I is voltooid, nu kunt u verder gaan met deel 2; installeren van de Sunshower Deluxe Health.
- DE: Teil I ist fertige, Jetzt können Sie mit Teil 2 fort; montieren Sunshower Deluxe Health.